

PRODUCT SPECIFICATION GUIDE FOR - SHOWER GRABRAILS

LIBERTY BAR

DESCRIPTION

Stainless Steel Shower Grabrail for general use.
Manufactured to Comply with AS1428.1:2021

SPECIFICATION

Material: Stainless Steel 304 grade
 Tube Diameter: 32mm
 Wall Thickness: 1.2mm
 Finish: Satin Stainless
 Mounting: Stainless Steel 76mmØ concealed flange
 Multiple fixing holes

FINISHES

Satin finish
 Powder coated finish (available to order)

FASTENERS (supplied with each grabrail)

Stainless Steel 304 Grade
 #10 X 50mm Pan Head Philips Drive Screws

RECOMMENDATIONS

Use with:
 EGHR.SH Sliding Shower Bracket & Hand Shower Set.
 EGHR.SD Sliding Soap Basket

Designed for the safety, security & convenience,
 for a person with a disability.
 Easy to install on most building surfaces.

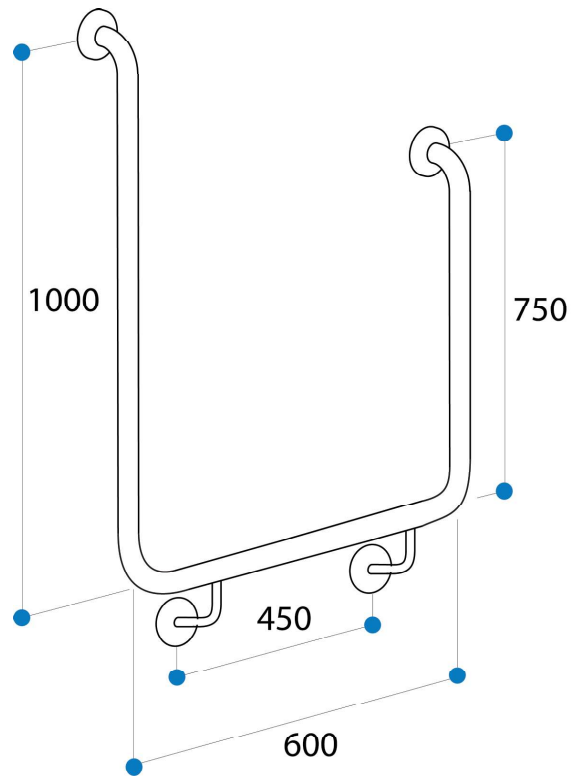

Standard Underslung Support

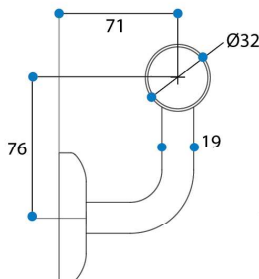

Standard Grabrail Bend with TIG Welded Fixing Flange

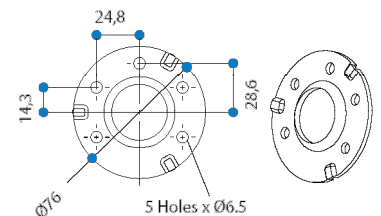
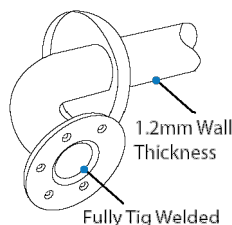
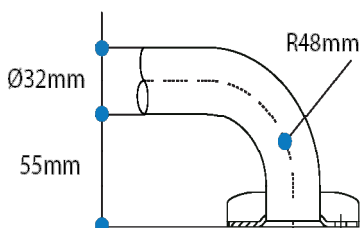

PRODUCT SPECIFICATION GUIDE FOR - SHOWER GRABRAILS

LIBERTY BAR

PRODUCTS AVAILABLE

Code	Description	Horizontal	Vertical
DLIB1000L	U Shaped - As Shown - (Left)	600mm	750mm & 1000mm
DLIB1000R	U Shaped - Opposite Hand	600mm	1000mm & 750mm

Optional Extras

Sliding Handshower Bracket

Sliding Soap Basket



INSTALLATION INSTRUCTIONS

Recommended Installation Height

To comply with Australian Standards AS 1428.1:2021, horizontal grabrails must be fastened a distance of 800-820mm from the floor (Measured to the top of the rail).

Careful planning is required to prepare the wall structures or to investigate the soundness of any existing substrates, followed by selecting the most suitable fixings for the conditions. The fastenings should be able to withstand a force of 1100N at any point from any direction.

It is recommended that suitably qualified persons, carry out installation and reference to Australian Standard requirements should be made to ensure the installation complies with all requirements.

WARRANTY

Axess Trading Products as described in the heading, are guaranteed to be free from defective materials and workmanship for a period of 5 years from the date of purchase, subject to the product being used for the purpose for which it was designed.

Under this warranty, products returned to Axess Trading will be repaired or replaced at no extra charge to the purchaser. Please contact us for our complete warranty certificate.

PRODUCT SPECIFICATION GUIDE FOR - SHOWER GRABRAILS

STYLE - EGS20

DESCRIPTION

Stainless Steel Shower Grabrail for general use.
Manufactured to Comply with AS1428.1:2021

SPECIFICATION

Material: Stainless Steel 304 grade
 Tube Diameter: 32mm
 Wall Thickness: 1.2mm
 Finish: Satin Stainless
 Mounting: Stainless Steel 76mmØ concealed flange
 Multiple fixing holes

FINISHES

Satin finish
 Powder coated finish (available to order)

FASTENERS (supplied with each grabrail)

Stainless Steel 304 Grade
 #10 X 50mm Pan Head Philips Drive Screws

RECOMMENDATIONS

Use with:
 EGHR.SH Sliding Shower Bracket & Hand Shower Set.
 EGHR.SD Sliding Soap Basket

Designed for the safety, security & convenience,
 for a person with a disability.
 Easy to install on most building surfaces.

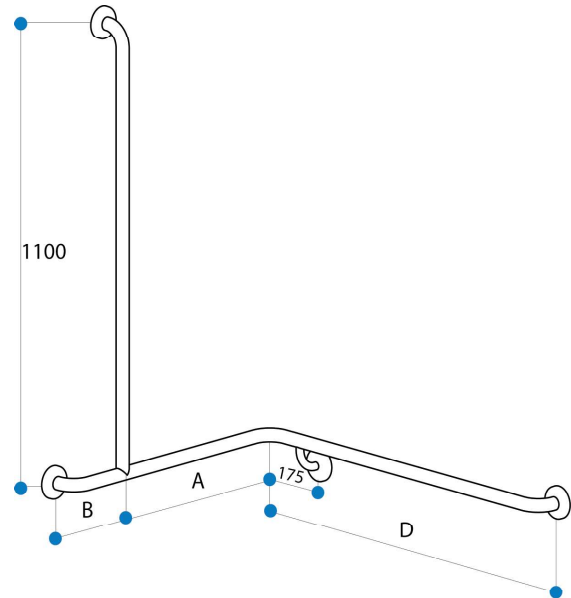

Standard Underslung Support

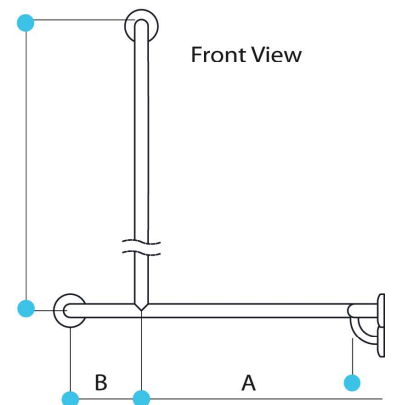
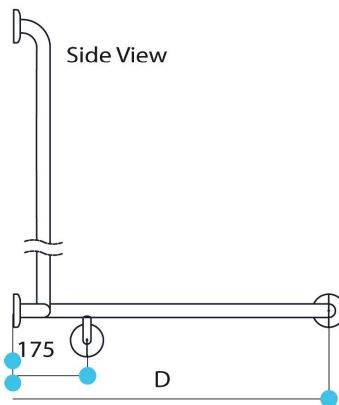
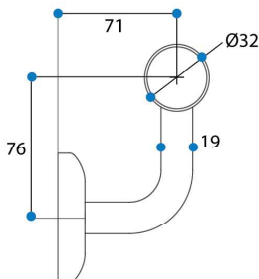

Standard Grabrail Bend with TIG Welded Fixing Flange

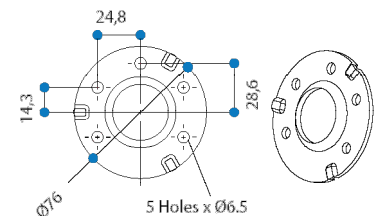
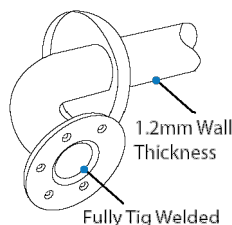
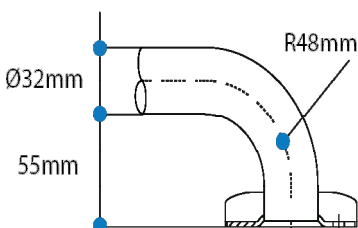

PRODUCT SPECIFICATION GUIDE FOR - SHOWER GRABRAILS

STYLE - EGS20

PRODUCTS AVAILABLE

Code	Description		A	B	D
EGS20.10.SCX	Corner with Vertical - As Shown - (Left)	750mm x 1000mm	580mm	170mm	1000mm
EGS20.11.SCX	Corner with Vertical - Opposite Hand	750mm x 1000mm	580mm	170mm	1000mm
EGS20.20.SCX	Corner with Vertical - As Shown - (Left)	1000mm x 1000mm	580mm	420mm	1000mm
EGS20.21.SCX	Corner with Vertical - Opposite Hand	1000mm x 1000mm	580mm	420mm	1000mm
EGS20.30.SCX	Corner with Vertical - As Shown - (Left)	750mm x 750mm	450mm	300mm	750mm
EGS20.31.SCX	Corner with Vertical - Opposite Hand	750mm x 750mm	450mm	300mm	750mm
EGS20.40.SCX	Corner with Vertical - As Shown - (Left)	900mm x 900mm	580mm	320mm	900mm
EGS20.41.SCX	Corner with Vertical - Opposite Hand	900mm x 900mm	580mm	320mm	900mm

Optional Extras

Sliding Handshower Bracket
Sliding Soap Basket



INSTALLATION INSTRUCTIONS

Recommended Installation Height

To comply with Australian Standards AS 1428.1:2021, horizontal grabrails must be fastened a distance of 800-820mm from the floor (Measured to the top of the rail).

Careful planning is required to prepare the wall structures or to investigate the soundness of any existing substrates, followed by selecting the most suitable fixings for the conditions. The fastenings should be able to withstand a force of 1100N at any point from any direction.

It is recommended that suitably qualified persons, carry out installation and reference to Australian Standard requirements should be made to ensure the installation complies with all requirements.

WARRANTY

Axess Trading Products as described in the heading, are guaranteed to be free from defective materials and workmanship for a period of 5 years from the date of purchase, subject to the product being used for the purpose for which it was designed.

Under this warranty, products returned to Axess Trading will be repaired or replaced at no extra charge to the purchaser. Please contact us for our complete warranty certificate.

PRODUCT SPECIFICATION GUIDE FOR - SHOWER GRABRAILS

STYLE - EGS20 (CONNECTA)

DESCRIPTION

Stainless Steel Shower Grabrail for general use.
Manufactured to Comply with AS1428.1:2021

SPECIFICATION

Material	Stainless Steel 304 grade
Tube Diameter	32mm
Wall Thickness	1.2mm
Finish	Satin Stainless
Mounting	Stainless Steel 76mmØ concealed flange Multiple fixing holes

FINISHES

Satin finish
Powder coated finish (available to order)

FASTENERS (supplied with each grabrail)

Stainless Steel 304 Grade
#10 X 50mm Pan Head Philips Drive Screws

RECOMMENDATIONS

Use with:
EGHR.SH Sliding Shower Bracket & Hand Shower Set.
EGHR.SD Sliding Soap Basket

Designed for the safety, security & convenience,
for a person with a disability.
Easy to install on most building surfaces.

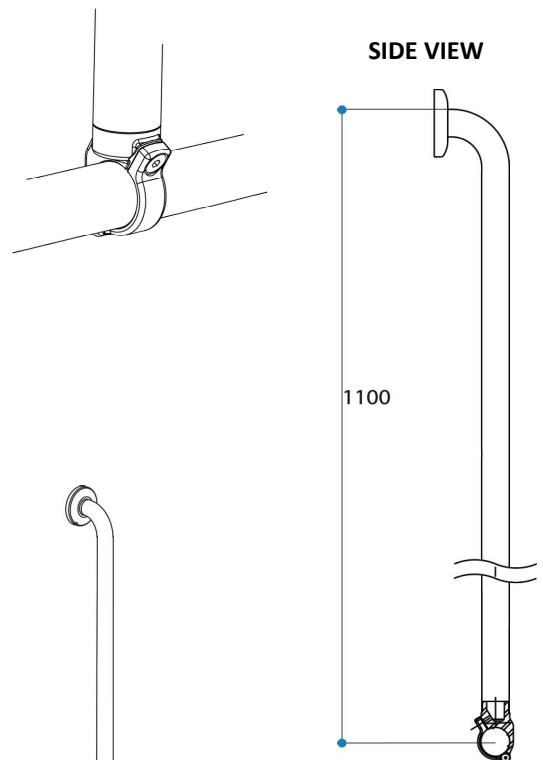

Standard Underslung Support

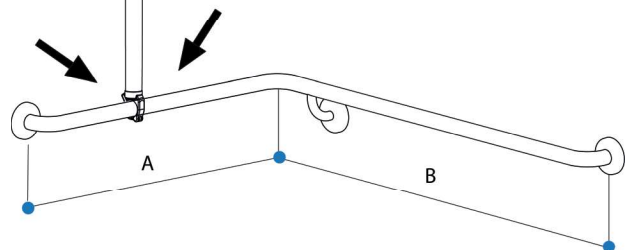
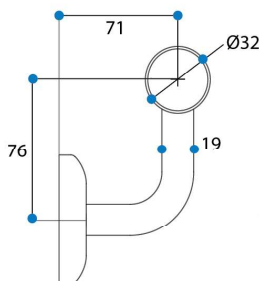

Standard Grabrail Bend with TIG Welded Fixing Flange

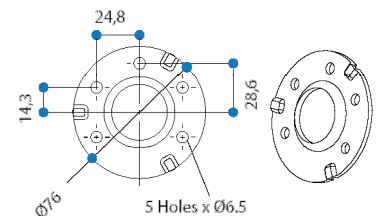
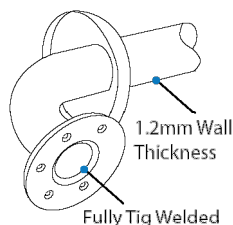
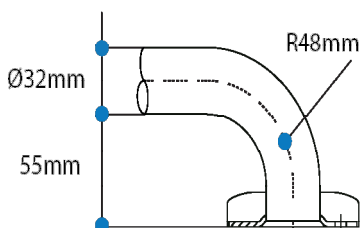

PRODUCT SPECIFICATION GUIDE FOR - SHOWER GRABRAILS

STYLE - EGS20 (CONNECTA)

PRODUCTS AVAILABLE

Code	Description	A	B	Vertical Connecta
EGS20.10.SCCR	Corner with Vertical - As Shown - (Left)	750mm	1000mm	1100mm
EGS20.11.SCCR	Corner with Vertical - Opposite Hand	750mm	1000mm	1100mm
EGS20.20.SCCR	Corner with Vertical - As Shown - (Left)	1000mm	1000mm	1100mm
EGS20.21.SCCR	Corner with Vertical - Opposite Hand	1000mm	1000mm	1100mm
EGS20.30.SCCR	Corner with Vertical - As Shown - (Left)	750mm	750mm	1100mm
EGS20.31.SCCR	Corner with Vertical - Opposite Hand	750mm	750mm	1100mm
EGS20.40.SCCR	Corner with Vertical - As Shown - (Left)	900mm	900mm	1100mm
EGS20.41.SCCR	Corner with Vertical - Opposite Hand	900mm	900mm	1100mm

Optional Extras

Sliding Handshower Bracket
Sliding Soap Basket

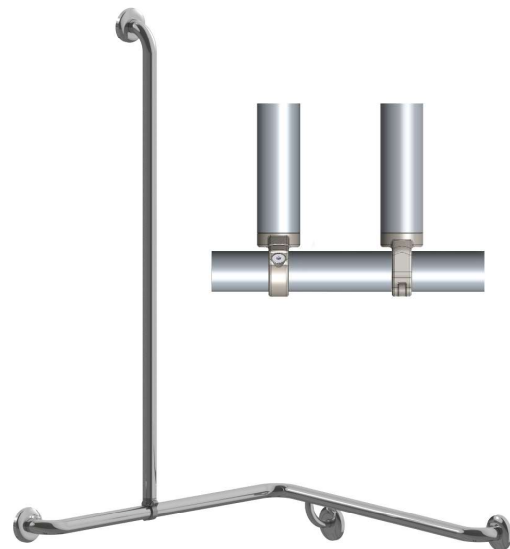

INSTALLATION INSTRUCTIONS

Recommended Installation Height

To comply with Australian Standards AS 1428.1:2021, horizontal grabrails must be fastened a distance of 800-820mm from the floor (Measured to the top of the rail).

Careful planning is required to prepare the wall structures or to investigate the soundness of any existing substrates, followed by selecting the most suitable fixings for the conditions. The fastenings should be able to withstand a force of 1100N at any point from any direction.

It is recommended that suitably qualified persons, carry out installation and reference to Australian Standard requirements should be made to ensure the installation complies with all requirements.

WARRANTY

Axess Trading Products as described in the heading, are guaranteed to be free from defective materials and workmanship for a period of 5 years from the date of purchase, subject to the product being used for the purpose for which it was designed.

Under this warranty, products returned to Axess Trading will be repaired or replaced at no extra charge to the purchaser. Please contact us for our complete warranty certificate.

PRODUCT SPECIFICATION GUIDE FOR - SHOWER GRABRAILS

STYLE - EGS25

DESCRIPTION

Stainless Steel Shower Grabrail for general use.
Manufactured to Comply with AS1428.1:2021

SPECIFICATION

Material: Stainless Steel 304 grade
 Tube Diameter: 32mm
 Wall Thickness: 1.2mm
 Finish: Satin Stainless
 Mounting: Stainless Steel 76mmØ concealed flange
 Multiple fixing holes

FINISHES

Satin finish
 Powder coated finish (available to order)

FASTENERS (supplied with each grabrail)

Stainless Steel 304 Grade
 #10 X 50mm Pan Head Philips Drive Screws

RECOMMENDATIONS

Use with:
 EGHR.SH Sliding Shower Bracket & Hand Shower Set.
 EGHR.SD Sliding Soap Basket

Designed for the safety, security & convenience,
 for a person with a disability.
 Easy to install on most building surfaces.

ACCESSIBLE FACILITY

* Compliant with AS1428.1:2021, if installed according to the provisions of the standard

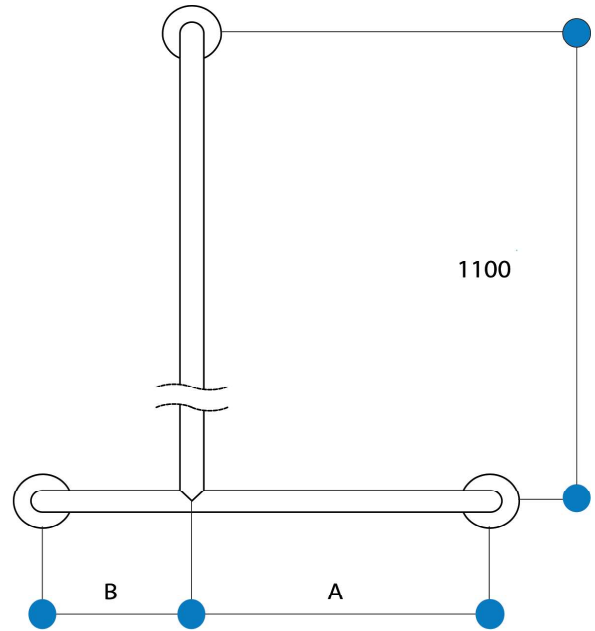

SIDE VIEW

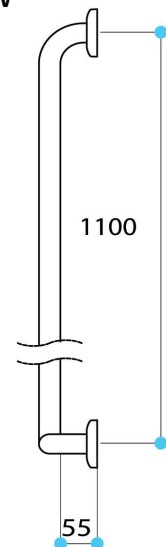

Standard Grabrail Bend with TIG Welded Fixing Flange

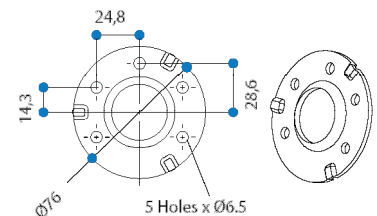
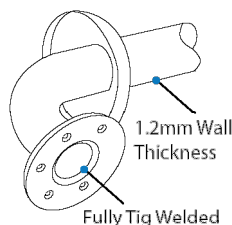
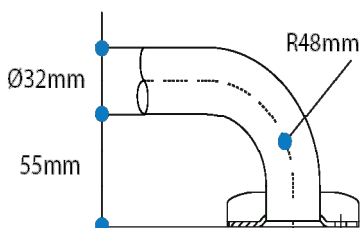

PRODUCT SPECIFICATION GUIDE FOR - SHOWER GRABRAILS

STYLE - EGS25

PRODUCTS AVAILABLE

Code	Description			A	B
EGS25.10.SC	T Rail - As Shown - (Left)		600mm	400mm	200mm
EGS25.11.SC	T Rail - Opposite Hand		600mm	400mm	200mm
EGS25.20.SC	T Rail - Centered		600mm	300mm	300mm
EGS25.30.SC	T Rail - As Shown - (Left)	AS1428.1:2021 *	675mm	500mm	175mm
EGS25.31.SC	T Rail - Opposite Hand	AS1428.1:2021 *	675mm	500mm	175mm
EGS26.10.SC	T Rail - As Shown - (Left)	AS1428.1:2021 *	1200mm	1025mm	175mm
EGS26.11.SC	T Rail - Opposite Hand	AS1428.1:2021 *	1200mm	1025mm	175mm

Optional Extras

Sliding Handshower Bracket
Sliding Soap Basket



INSTALLATION INSTRUCTIONS

Recommended Installation Height

To comply with Australian Standards AS 1428.1:2021, horizontal grabrails must be fastened a distance of 800-820mm from the floor (Measured to the top of the rail).

Careful planning is required to prepare the wall structures or to investigate the soundness of any existing substrates, followed by selecting the most suitable fixings for the conditions. The fastenings should be able to withstand a force of 1100N at any point from any direction.

It is recommended that suitably qualified persons, carry out installation and reference to Australian Standard requirements should be made to ensure the installation complies with all requirements.

WARRANTY

Axess Trading Products as described in the heading, are guaranteed to be free from defective materials and workmanship for a period of 5 years from the date of purchase, subject to the product being used for the purpose for which it was designed.

Under this warranty, products returned to Axess Trading will be repaired or replaced at no extra charge to the purchaser. Please contact us for our complete warranty certificate.

PRODUCT SPECIFICATION GUIDE FOR - SHOWER GRABRAILS

STYLE - EGS25 (WITH CONNECTA)

DESCRIPTION

Stainless Steel Shower Grabrail for general use.
Manufactured to Comply with AS1428.1:2021

SPECIFICATION

Material: Stainless Steel 304 grade
 Tube Diameter: 32mm
 Wall Thickness: 1.2mm
 Finish: Satin Stainless
 Mounting: Stainless Steel 76mmØ concealed flange
 Multiple fixing holes

FINISHES

Satin finish
 Powder coated finish (available to order)

FASTENERS (supplied with each grabrail)

Stainless Steel 304 Grade
 #10 X 50mm Pan Head Philips Drive Screws

RECOMMENDATIONS

Use with:
 EGHR.SH Sliding Shower Bracket & Hand Shower Set.
 EGHR.SD Sliding Soap Basket

Designed for the safety, security & convenience,
 for a person with a disability.
 Easy to install on most building surfaces.

SIDE VIEW

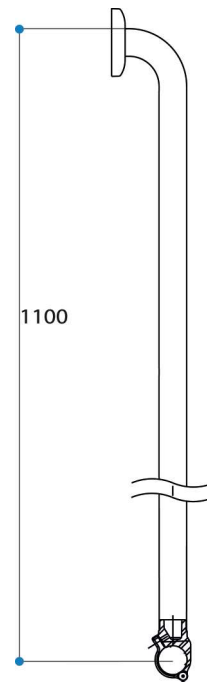

CS32 - Any 32mm Horizontal Grabrail

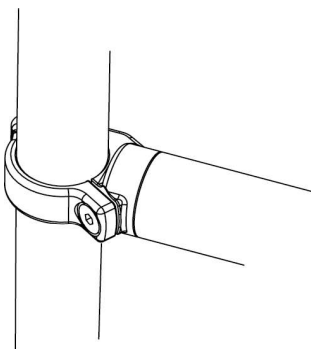

The Vertical **Connecta Rail** is designed to be securely attached to a 32mm Horizontal Shower Rail even after the initial build.

Standard Grabrail Bend with TIG Welded Fixing Flange

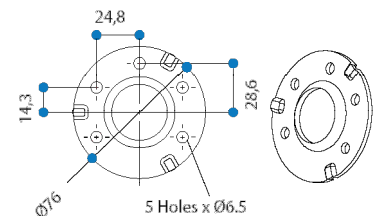
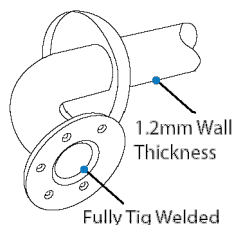
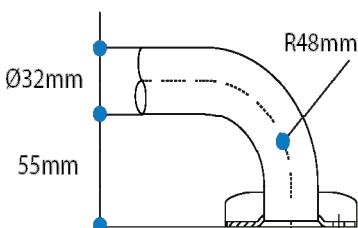

PRODUCT SPECIFICATION GUIDE FOR - SHOWER GRABRAILS

STYLE - EGS25 (WITH CONNECTA)

PRODUCTS AVAILABLE

Code	Description		Standard Grabrail Length	Vertical Connecta
EGS25.1.SCCR	T Rail - As Shown		600mm	1100mm
EGS25.3.SCCR	T Rail - As Shown	AS1428.1:2021 *	675mm	1100mm
EGS26.1.SCCR	T Rail - As Shown	AS1428.1:2021 *	1200mm	1100mm

Optional Extras

Sliding Handshower Bracket
Sliding Soap Basket



Back View



Front View

ACCESSIBLE FACILITY

* Compliant with AS1428.1:2021, if installed according to the provisions of the standard

INSTALLATION INSTRUCTIONS

Recommended Installation Height

To comply with Australian Standards AS 1428.1:2021, horizontal grabrails must be fastened a distance of 800-820mm from the floor (Measured to the top of the rail).

Careful planning is required to prepare the wall structures or to investigate the soundness of any existing substrates, followed by selecting the most suitable fixings for the conditions. The fastenings should be able to withstand a force of 1100N at any point from any direction.

It is recommended that suitably qualified persons, carry out installation and reference to Australian Standard requirements should be made to ensure the installation complies with all requirements.

WARRANTY

Axess Trading Products as described in the heading, are guaranteed to be free from defective materials and workmanship for a period of 5 years from the date of purchase, subject to the product being used for the purpose for which it was designed.

Under this warranty, products returned to Axess Trading will be repaired or replaced at no extra charge to the purchaser. Please contact us for our complete warranty certificate.

PRODUCT SPECIFICATION GUIDE FOR - SHOWER GRABRAILS

STYLE - EGS10 (CONNECTA RAIL)

DESCRIPTION

Stainless Steel Shower Grabrail for general use.
Manufactured to Comply with AS1428.1:2021

SPECIFICATION

Material: Stainless Steel 304 grade
 Tube Diameter: 32mm
 Wall Thickness: 1.2mm
 Finish: Satin Stainless
 Mounting: Stainless Steel 76mmØ concealed flange
 Multiple fixing holes

FINISHES

Satin finish
 Powder coated finish (available to order)

FASTENERS (supplied with each grabrail)

Stainless Steel 304 Grade
 #10 X 50mm Pan Head Philips Drive Screws

RECOMMENDATIONS

Use with:
 EGHR.SH Sliding Shower Bracket & Hand Shower Set.
 EGHR.SD Sliding Soap Basket

Designed for the safety, security & convenience,
 for a person with a disability.
 Easy to install on most building surfaces.

SIDE VIEW

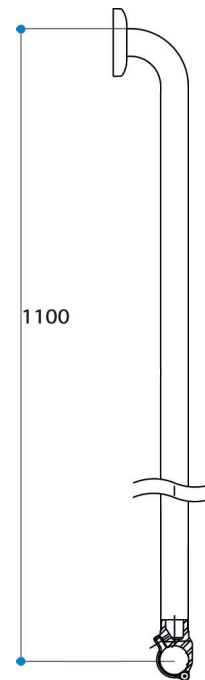

The Vertical **Connecta Rail** is designed to be securely attached to a 32mm Horizontal Shower Rail even after the initial build.

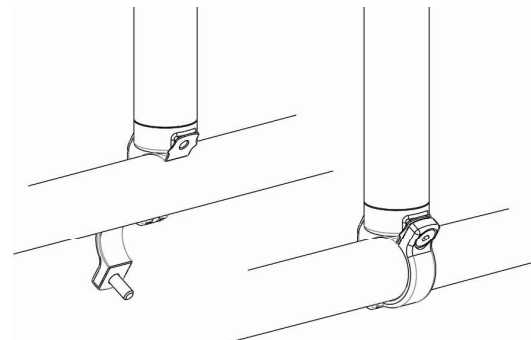
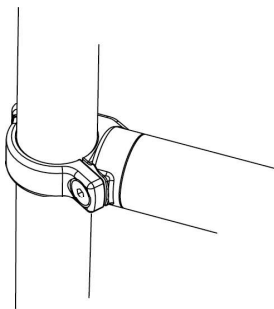

Standard Grabrail Bend with TIG Welded Fixing Flange

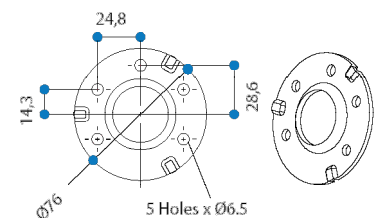
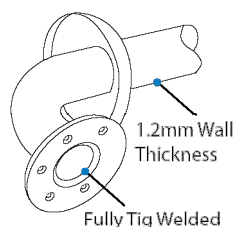
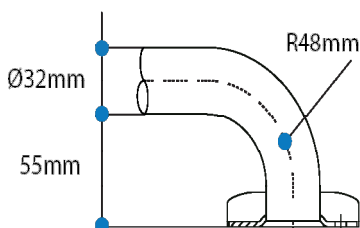

PRODUCT SPECIFICATION GUIDE FOR - SHOWER GRABRAILS

STYLE - EGS10 (CONNECTA RAIL)

PRODUCTS AVAILABLE

Code	Description
EGS10.SCA	1100mm from base of fitting - Fits any 32mm Diameter Grabrail



Back View

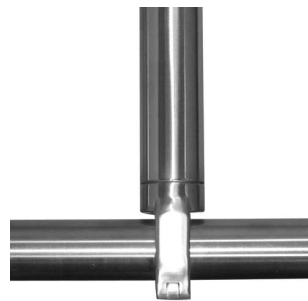

Front View

Optional Extras

- Sliding Handshower Bracket
- Sliding Soap Basket



INSTALLATION INSTRUCTIONS

Recommended Installation Height

To comply with Australian Standards AS 1428.1:2021, horizontal grabrails must be fastened a distance of 800-820mm from the floor (Measured to the top of the rail).

Careful planning is required to prepare the wall structures or to investigate the soundness of any existing substrates, followed by selecting the most suitable fixings for the conditions. The fastenings should be able to withstand a force of 1100N at any point from any direction.

It is recommended that suitably qualified persons, carry out installation and reference to Australian Standard requirements should be made to ensure the installation complies with all requirements.

WARRANTY

Axess Trading Products as described in the heading, are guaranteed to be free from defective materials and workmanship for a period of 5 years from the date of purchase, subject to the product being used for the purpose for which it was designed.

Under this warranty, products returned to Axess Trading will be repaired or replaced at no extra charge to the purchaser. Please contact us for our complete warranty certificate.

PRODUCT SPECIFICATION GUIDE FOR - SHOWER GRABRAILS

STYLE - EGS22

DESCRIPTION

Stainless Steel Shower Grabrail for general use.
Manufactured to Comply with AS1428.1:2021

SPECIFICATION

Material	Stainless Steel 304 grade
Tube Diameter	32mm
Wall Thickness	1.2mm
Finish	Satin Stainless
Mounting	Stainless Steel 76mmØ concealed flange Multiple fixing holes

FINISHES

Satin finish
Powder coated finish (available to order)

FASTENERS (supplied with each grabrail)

Stainless Steel 304 Grade
#10 X 50mm Pan Head Philips Drive Screws

RECOMMENDATIONS

Use with:
EGHR.SH Sliding Shower Bracket & Hand Shower Set.
EGHR.SD Sliding Soap Basket

Designed for the safety, security & convenience,
for a person with a disability.
Easy to install on most building surfaces.

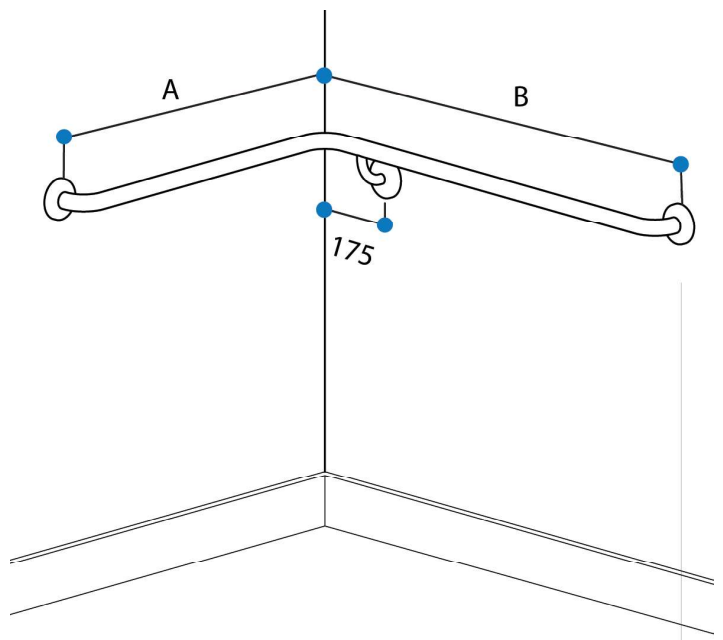

Standard Underslung Support

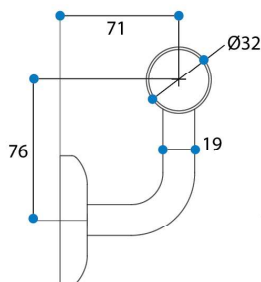

Standard Grabrail Bend with TIG Welded Fixing Flange

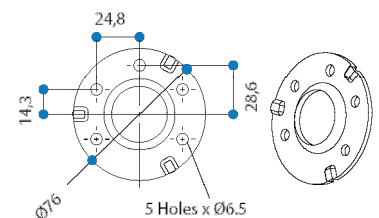
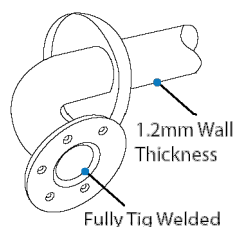
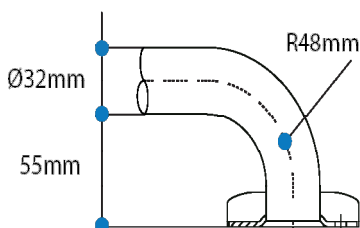

PRODUCT SPECIFICATION GUIDE FOR - SHOWER GRABRAILS

STYLE - EGS22

PRODUCTS AVAILABLE

Code	Description	A	B
EGS22.10.SCX	Corner Grabrail - As Shown - (Left)	750mm	1000mm
EGS22.11.SCX	Corner Grabrail - Opposite Hand	750mm	1000mm
EGS22.20.SCX	Corner Grabrail - As Shown - (Left)	1000mm	1000mm
EGS22.21.SCX	Corner Grabrail - Opposite Hand	1000mm	1000mm
EGS22.30.SCX	Corner Grabrail - As Shown - (Left)	750mm	750mm
EGS22.31.SCX	Corner Grabrail - Opposite Hand	750mm	750mm
EGS22.40.SCX	Corner Grabrail - As Shown - (Left)	900mm	900mm
EGS22.41.SCX	Corner Grabrail - Opposite Hand	900mm	900mm

RECOMMENDATIONS

Use with: Vertical Connecta Rail
& EGHR Sliding Shower Bracket

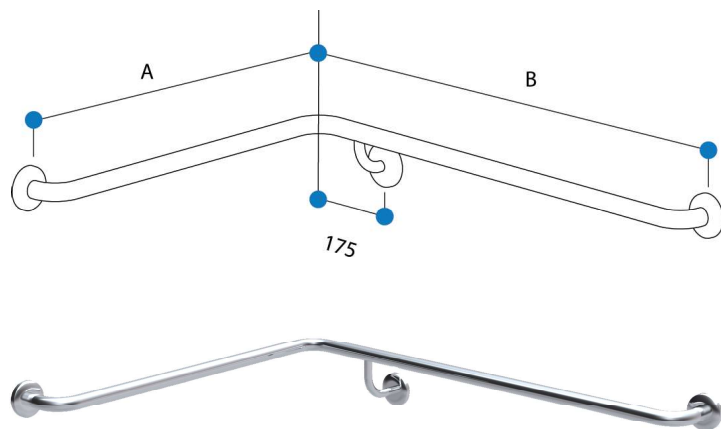

INSTALLATION INSTRUCTIONS

Recommended Installation Height

To comply with Australian Standards AS 1428.1:2021, horizontal grabrails must be fastened a distance of 800-820mm from the floor (Measured to the top of the rail).

Careful planning is required to prepare the wall structures or to investigate the soundness of any existing substrates, followed by selecting the most suitable fixings for the conditions. The fastenings should be able to withstand a force of 1100N at any point from any direction.

It is recommended that suitably qualified persons, carry out installation and reference to Australian Standard requirements should be made to ensure the installation complies with all requirements.

WARRANTY

Axess Trading Products as described in the heading, are guaranteed to be free from defective materials and workmanship for a period of 5 years from the date of purchase, subject to the product being used for the purpose for which it was designed.

Under this warranty, products returned to Axess Trading will be repaired or replaced at no extra charge to the purchaser. Please contact us for our complete warranty certificate.

PRODUCT SPECIFICATION GUIDE FOR - SHOWER GRABRAILS

STYLE - EGS27

DESCRIPTION

Stainless Steel Shower Grabrail for general use.
Manufactured to Comply with AS1428.1:2021

SPECIFICATION

Material: Stainless Steel 304 grade
 Tube Diameter: 32mm
 Wall Thickness: 1.2mm
 Finish: Satin Stainless
 Mounting: Stainless Steel 76mmØ concealed flange
 Multiple fixing holes

FINISHES

Satin finish
 Powder coated finish (available to order)

FASTENERS (supplied with each grabrail)

Stainless Steel 304 Grade
 #10 X 50mm Pan Head Philips Drive Screws

RECOMMENDATIONS

Use with:
 EGHR.SH Sliding Shower Bracket & Hand Shower Set.
 EGHR.SD Sliding Soap Basket

Designed for the safety, security & convenience,
 for a person with a disability.
 Easy to install on most building surfaces.

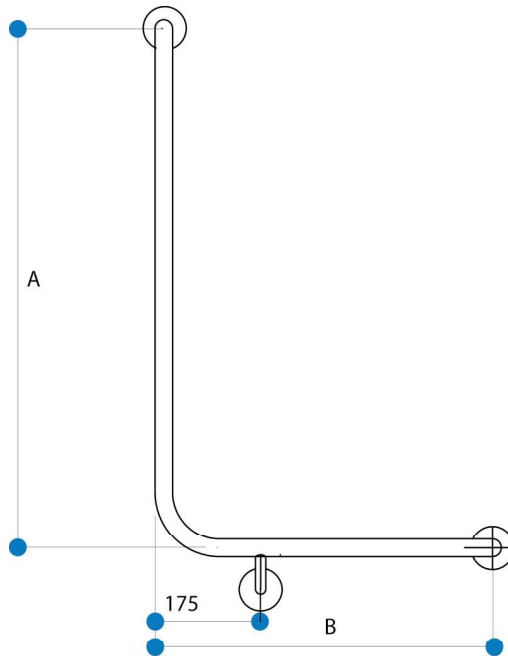

Standard Underslung Support

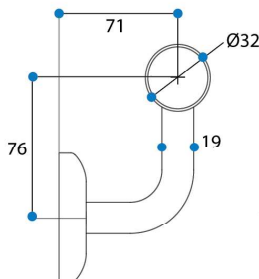

Standard Grabrail Bend with TIG Welded Fixing Flange

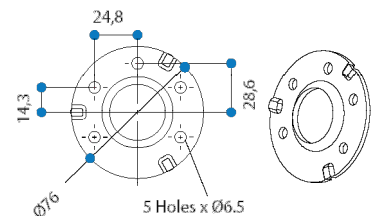
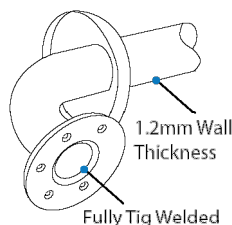
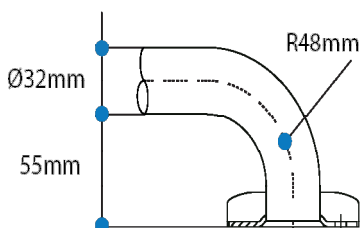

PRODUCT SPECIFICATION GUIDE FOR - SHOWER GRABRAILS

STYLE - EGS27

PRODUCTS AVAILABLE

Code	Description	A	B
EGS27.20.SCX	L Shaped - As Shown - (Left)	1000mm	600mm
EGS27.21.SCX	L Shaped - Opposite Hand	1000mm	600mm

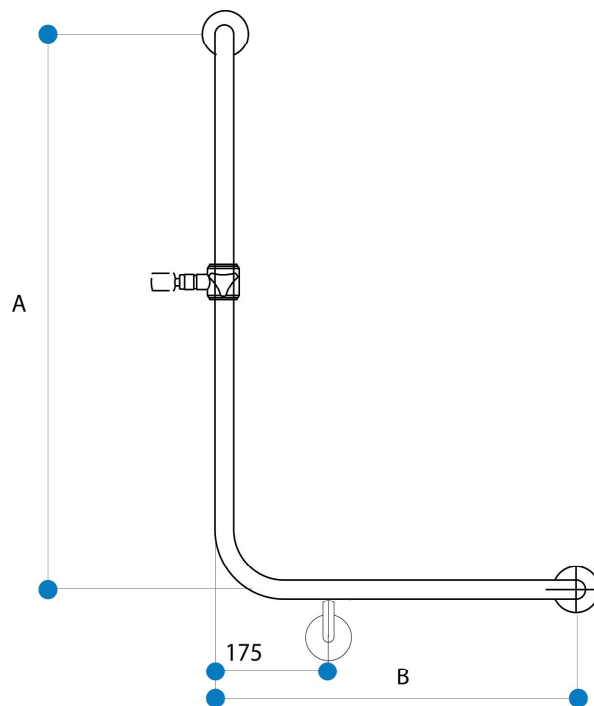

INSTALLATION INSTRUCTIONS

Recommended Installation Height

To comply with Australian Standards AS 1428.1:2021, horizontal grabrails must be fastened a distance of 800-820mm from the floor (Measured to the top of the rail).

Careful planning is required to prepare the wall structures or to investigate the soundness of any existing substrates, followed by selecting the most suitable fixings for the conditions. The fastenings should be able to withstand a force of 1100N at any point from any direction.

It is recommended that suitably qualified persons, carry out installation and reference to Australian Standard requirements should be made to ensure the installation complies with all requirements.

WARRANTY

Axess Trading Products as described in the heading, are guaranteed to be free from defective materials and workmanship for a period of 5 years from the date of purchase, subject to the product being used for the purpose for which it was designed.

Under this warranty, products returned to Axess Trading will be repaired or replaced at no extra charge to the purchaser. Please contact us for our complete warranty certificate.